

## HM2301BWKR

### Dual P-Channel Enhancement Mode Field Effect Transistor

<p><b>General Description</b></p> <p>The HM2301BWKR uses advanced trench technology to provide excellent <math>R_{DS(ON)}</math>, low gate charge, and operation with gate voltages as low as 1.8V, in the small SOT363 footprint. It can be used for a wide variety of applications, including load switching, low current inverters and low current DC-DC converters. It is ESD protected to 2KV HBM.</p>	<p><b>Features</b></p> <p><math>V_{DS} (V) = -20V</math>  <math>I_D = -0.8A (V_{GS} = -4.5V)</math></p> <p><math>R_{DS(ON)} &lt; 480m (V_{GS} = -4.5V)</math>  <math>R_{DS(ON)} &lt; 950m (V_{GS} = -2.5V)</math>  <math>R_{DS(ON)} &lt; 2200m (V_{GS} = -1.8V)</math></p> 
---	--

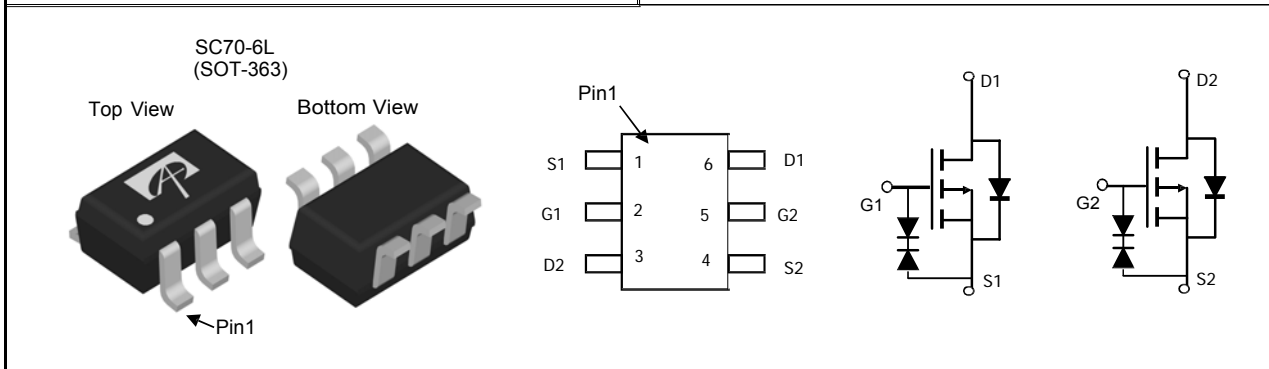

**Absolute Maximum Ratings**  $T_A=25^\circ C$  unless otherwise noted

Parameter	Symbol	Maximum	Units
Drain-Source Voltage	$V_{DS}$	-20	V
Gate-Source Voltage	$V_{GS}$	$\pm 8$	V
Continuous Drain Current <sup>A</sup>	$I_D$	$T_A=25^\circ C$	-0.8
		$T_A=70^\circ C$	-0.56
Pulsed Drain Current <sup>B</sup>	$I_{DM}$	-2.4	A
Power Dissipation <sup>A</sup>	$P_D$	$T_A=25^\circ C$	0.3
		$T_A=70^\circ C$	0.19
Junction and Storage Temperature Range	$T_J, T_{STG}$	-55 to 150	$^\circ C$

**Thermal Characteristics**

Parameter	Symbol	Typ	Max	Units
Maximum Junction-to-Ambient <sup>A</sup>	$R_{JA}$	360	415	$^\circ C/W$
Maximum Junction-to-Ambient <sup>A</sup>		Steady-State	400	460
Maximum Junction-to-Lead <sup>C</sup>	$R_{JL}$	300	350	$^\circ C/W$

Electrical Characteristics ( $T_J=25^\circ\text{C}$  unless otherwise noted)

Symbol	Parameter	Conditions	Min	Typ	Max	Units
<b>STATIC PARAMETERS</b>						
$BV_{DSS}$	Drain-Source Breakdown Voltage	$I_D=-250\text{ A}, V_{GS}=0\text{V}$	-20			V
$I_{DSS}$	Zero Gate Voltage Drain Current	$V_{DS}=-16\text{V}, V_{GS}=0\text{V}$			-1	A
		$T_J=55^\circ\text{C}$			-5	
$I_{GSS}$	Gate-Body leakage current	$V_{DS}=0\text{V}, V_{GS}=\pm 8\text{V}$			$\pm 10$	A
$V_{GS(th)}$	Gate Threshold Voltage	$V_{DS}=V_{GS}, I_D=-250\text{ A}$	-0.45		-1.2	V
$I_{D(ON)}$	On state drain current	$V_{GS}=-4.5\text{V}, V_{DS}=-5\text{V}$	-3			A
$R_{DS(ON)}$	Static Drain-Source On-Resistance	$V_{GS}=-4.5\text{V}, I_D=-0.8\text{A}$		350	480	m
		$T_J=125^\circ\text{C}$		440	670	
		$V_{GS}=-2.5\text{V}, I_D=-0.5\text{A}$		550	950	m
		$V_{GS}=-1.8\text{V}, I_D=-0.4\text{A}$		780	2200	m
$g_{FS}$	Forward Transconductance	$V_{DS}=-5\text{V}, I_D=-0.8\text{A}$		1.7		S
$V_{SD}$	Diode Forward Voltage	$I_S=-0.5\text{A}, V_{GS}=0\text{V}$		-0.86	-1	V
$I_S$	Maximum Body-Diode Continuous Current				-0.4	A
<b>DYNAMIC PARAMETERS</b>						
$C_{iss}$	Input Capacitance	$V_{GS}=0\text{V}, V_{DS}=-10\text{V}, f=1\text{MHz}$		114	140	pF
$C_{oss}$	Output Capacitance			17		
$C_{rss}$	Reverse Transfer Capacitance			14		
$R_g$	Gate resistance	$V_{GS}=0\text{V}, V_{DS}=0\text{V}, f=1\text{MHz}$		12	17	
<b>SWITCHING PARAMETERS</b>						
$Q_g$	Total Gate Charge	$V_{GS}=-4.5\text{V}, V_{DS}=-10\text{V}, I_D=-0.8\text{A}$		1.44	1.8	nC
$Q_{gs}$	Gate Source Charge			0.14		
$Q_{gd}$	Gate Drain Charge			0.35		
$t_{D(on)}$	Turn-On DelayTime	$V_{GS}=-4.5\text{V}, V_{DS}=-10\text{V},$ $R_L=16.7, R_{GEN}=3$		6.5		ns
$t_r$	Turn-On Rise Time			6.5		
$t_{D(off)}$	Turn-Off DelayTime			18.2		
$t_f$	Turn-Off Fall Time			5.5		
$t_{rr}$	Body Diode Reverse Recovery Time		$I_F=-0.8\text{A}, di/dt=100\text{A/s}$		10	
$Q_{rr}$	Body Diode Reverse Recovery Charge	$I_F=-0.8\text{A}, di/dt=100\text{A/s}$		3		nC

A: The value of  $R_{JA}$  is measured with the device mounted on 1in<sup>2</sup> FR-4 board with 2oz. Copper, in a still air environment with  $T_A=25^\circ\text{C}$ . The value in any a given application depends on the user's specific board design. The current rating is based on the  $t \leq 10\text{s}$  thermal resistance rating.

B: Repetitive rating, pulse width limited by junction temperature.

C: The  $R_{JA}$  is the sum of the thermal impedance from junction to lead  $R_{jL}$  and lead to ambient.

D: The static characteristics in Figures 1 to 6,12,14 are obtained using 80  $\mu\text{s}$  pulses, duty cycle 0.5% max.

E: These tests are performed with the device mounted on 1 in<sup>2</sup> FR-4 board with 2oz. Copper, in a still air environment with  $T_A=25^\circ\text{C}$ . The SOA curve provides a single pulse rating.

THIS PRODUCT HAS BEEN DESIGNED AND QUALIFIED FOR THE CONSUMER MARKET. APPLICATIONS OR USES AS CRITICAL COMPONENTS IN LIFE SUPPORT DEVICES OR SYSTEMS ARE NOT AUTHORIZED. AOS DOES NOT ASSUME ANY LIABILITY ARISING OUT OF SUCH APPLICATIONS OR USES OF ITS PRODUCTS. AOS RESERVES THE RIGHT TO IMPROVE PRODUCT DESIGN, FUNCTIONS AND RELIABILITY WITHOUT NOTICE.

## TYPICAL ELECTRICAL AND THERMAL CHARACTERISTICS

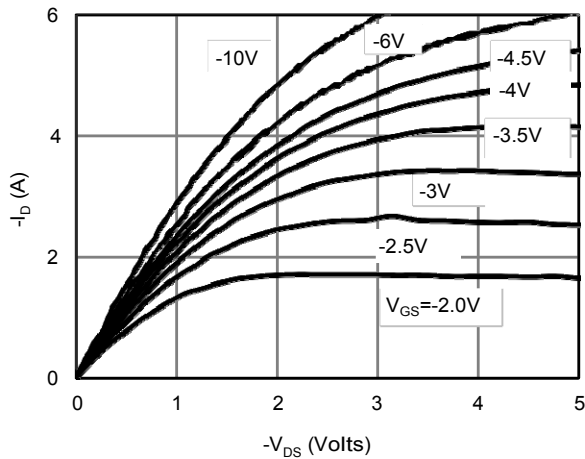

Fig 1: On-Region Characteristics

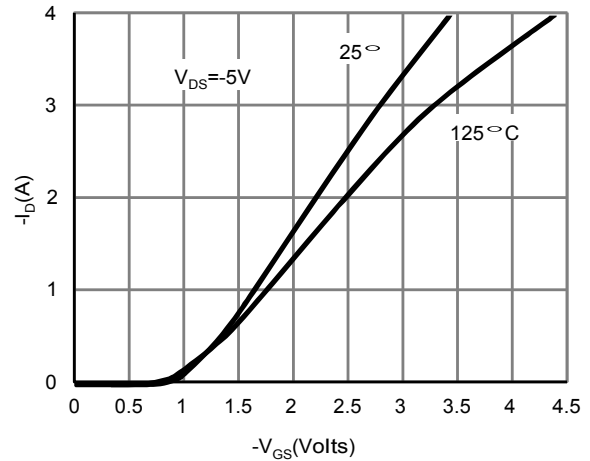

Figure 2: Transfer Characteristics

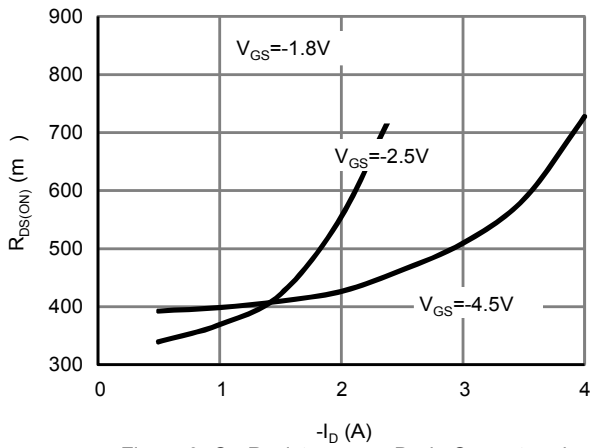

Figure 3: On-Resistance vs. Drain Current and Gate Voltage

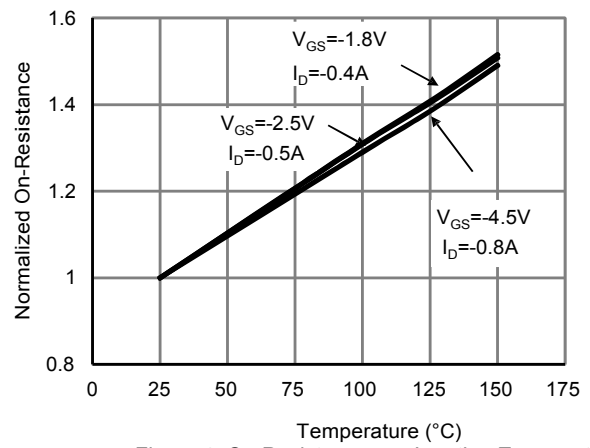

Figure 4: On-Resistance vs. Junction Temperature

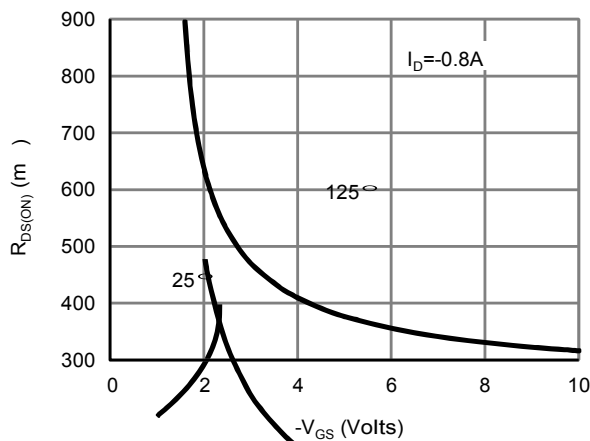

Figure 5: On-Resistance vs. Gate-Source Voltage

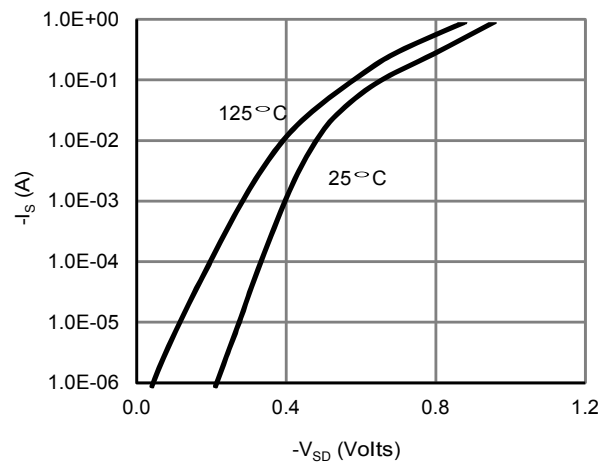

Figure 6: Body-Diode Characteristics

## TYPICAL ELECTRICAL AND THERMAL CHARACTERISTICS

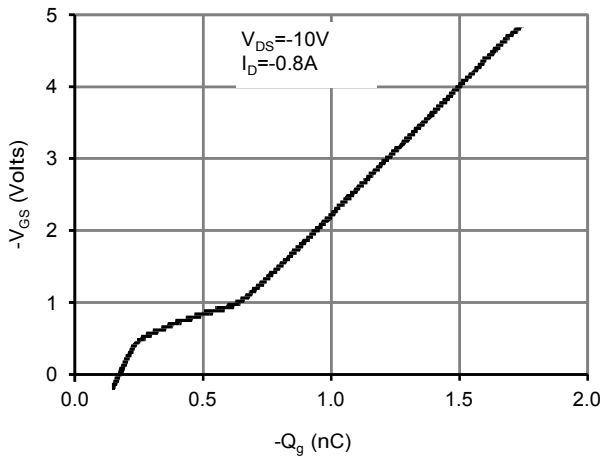

Figure 7: Gate-Charge Characteristics

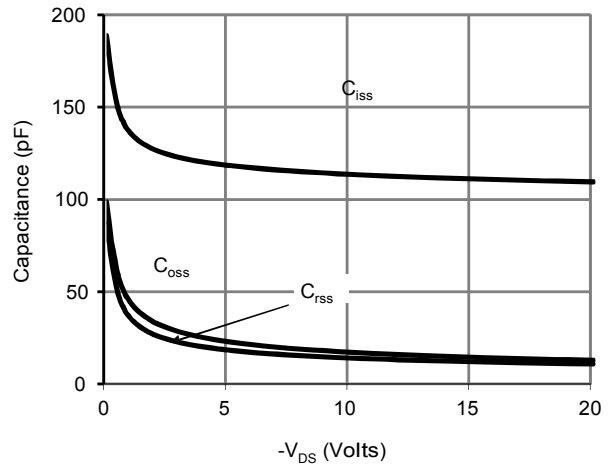

Figure 8: Capacitance Characteristics

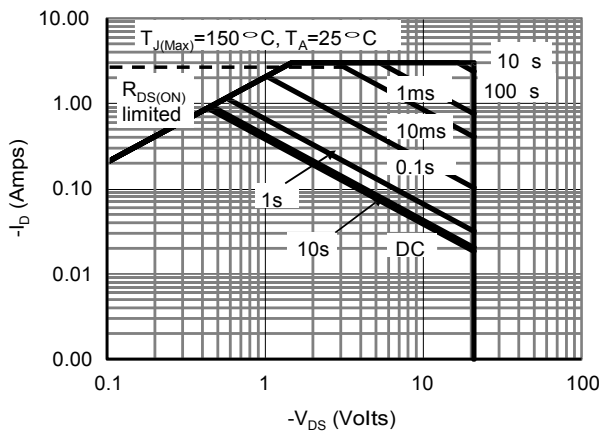

Figure 9: Maximum Forward Biased Safe Operating Area (Note E)

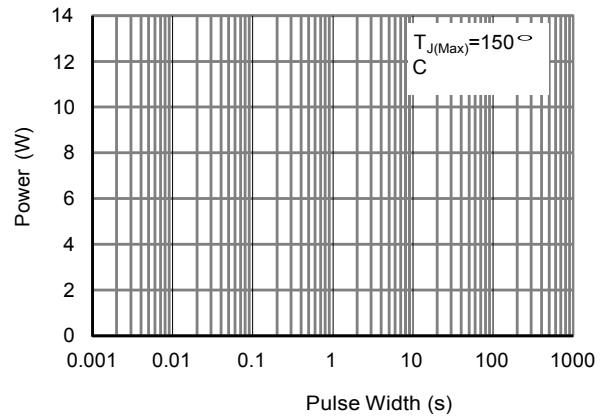

Figure 10: Single Pulse Power Rating Junction-to-Ambient (Note E)

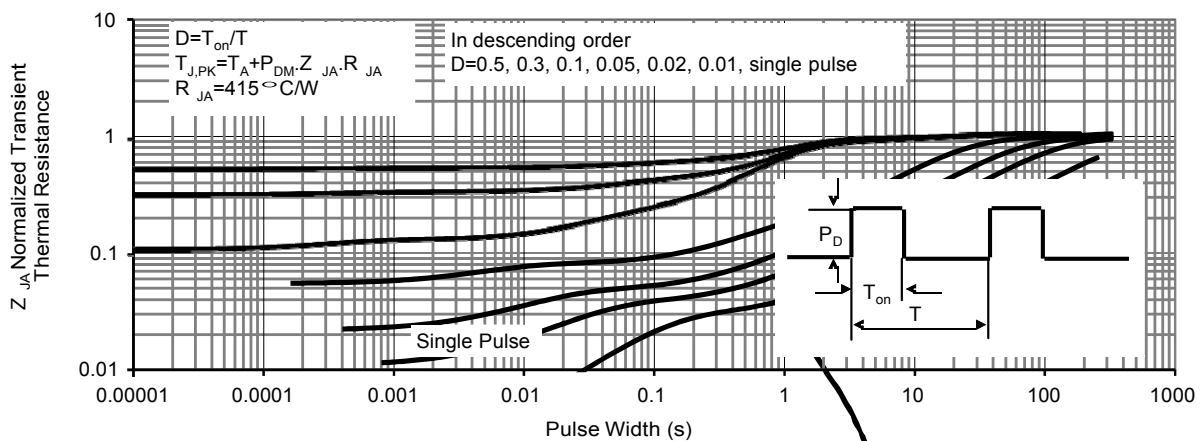
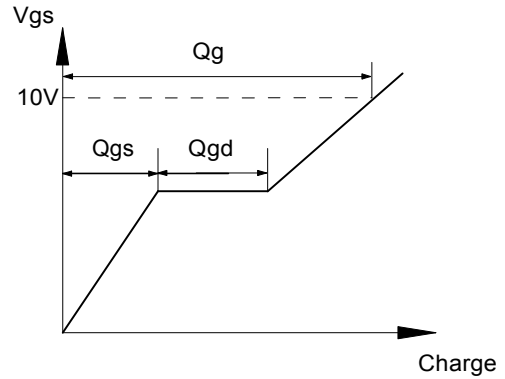
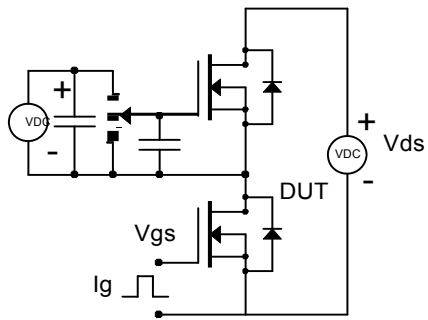
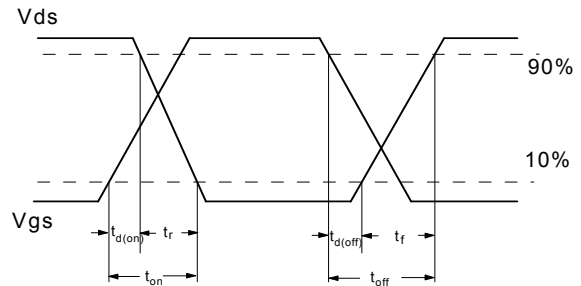
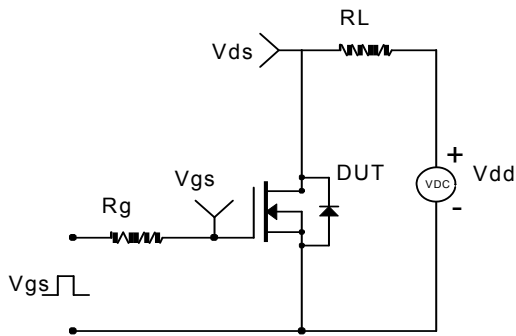

Figure 11: Normalized Maximum Transient Thermal Impedance

## Gate Charge Test Circuit & Waveform



## Resistive Switching Test Circuit & Waveforms



## Diode Recovery Test Circuit & Waveforms

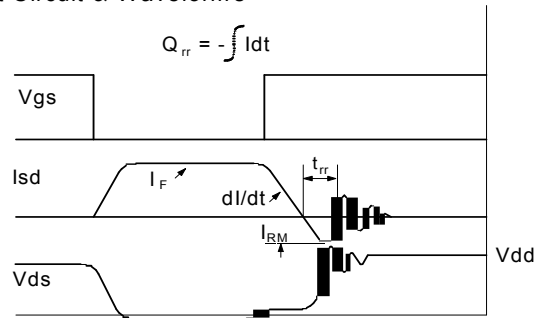
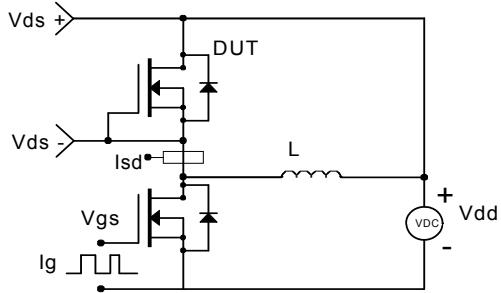

## PACKAGE OUTLINE

Plastic surface mounted package

SOT-363

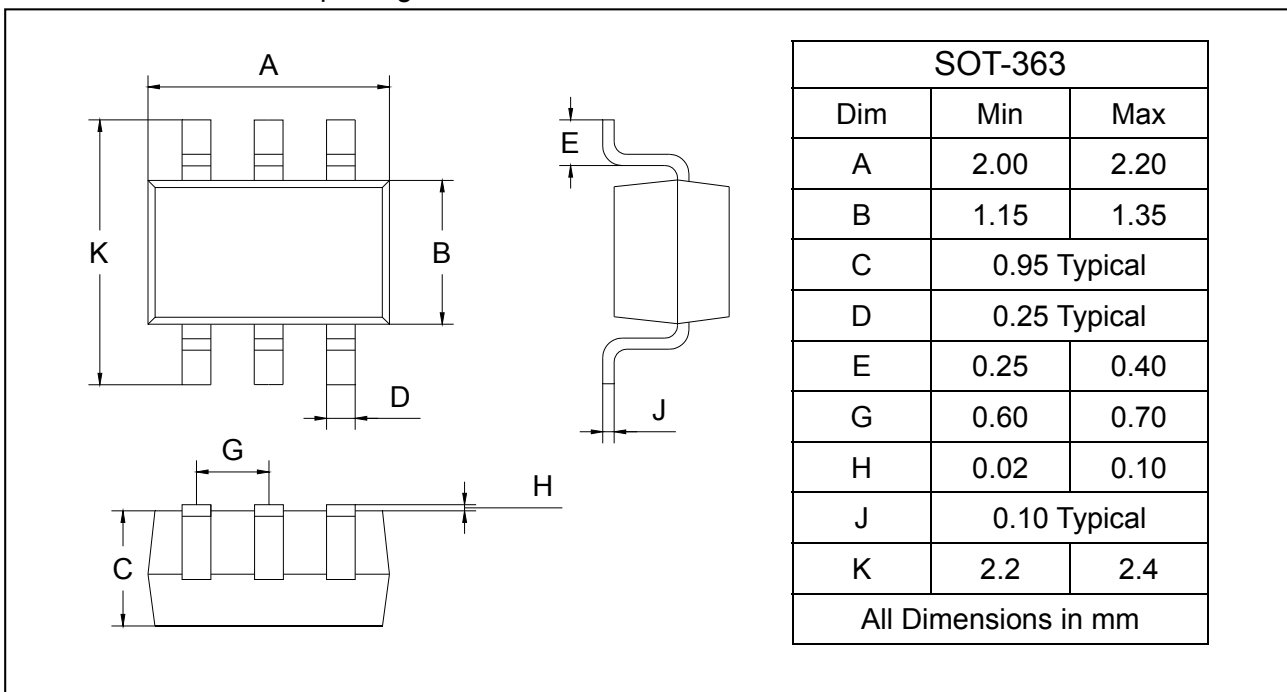

## SOLDERING FOOTPRINT

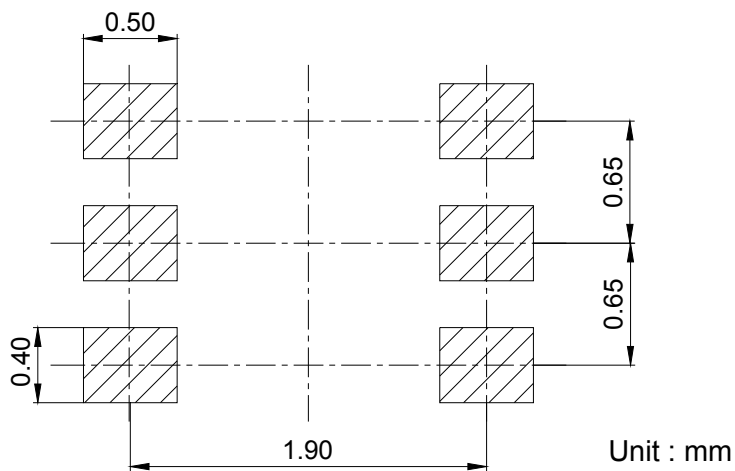

## PACKAGE INFORMATION

Device	Package	Shipping
HM2301BWKR	SOT-363	3000/Tape&Reel